



# MOREL PERFORMANCE SERIES AMPLIFIERS

## Owner's Manual

MPS 4.400 | MPS 1.550 | MPS 5.950



We thank you for choosing Morel amplifiers to complement your car audio system. The new MPS amplifiers were developed with the same passion and innovative philosophy that is driving all of Morel's product development. The MPS amplifiers are musical, dynamic, with clean, uncolored power that can drive speakers to their full sonic potential.

It is very important to carefully read this manual to ensure safe and optimal operation of the amplifier. We highly recommend to have a professional installer integrate the amp into the sound system. There are many parameters that needs to be taken into consideration when installing an amplifier to safeguard that the car's electrical system is not compromised in any way and the sound system is tuned properly.

## SERIAL NUMBER

Please take the time to enter the serial number in the space provided below.

The serial number can be found on the bottom panel of the amplifier and on the amplifier packaging. This is required in the event that your amplifier requires warranty service and may be helpful in recovering your amplifier in case of a theft. Be sure to store you this manual in a safe location.

**Serial Number:**

---



All Morel MPS amplifiers comply with CE and EMC regulations.



## PACKAGE CONTENT

- (1) MPS amplifier
- (1) 2mm hex wrench
- (1) 2.5mm hex wrench
- (1) 3mm hex wrench
- (4) Mounting screws
- (1) User manual
- (2) Top panel replacement screws

## AVAILABLE ACCESSORIES

- **MPS-R1** subwoofer remote level control (works with MPS 1.550 and MPS 5.950 only)
- **MPS-HL** high-low level adaptor with 50-ohm load resistor



### PRACTICE SAFE SOUND!

Studies have shown that continuous exposure to high sound pressure levels from high power audio systems can lead to permanent hearing loss. Additionally, high volume levels can obscure noises from outside your vehicle such as emergency vehicles and horns. As a valued Morel customer, we urge you to use common sense and practice restraint in the operation of this product.



### PRECAUTION

The MPS amplifiers are designed to work with a 12V DC electrical system with negative to ground. Use of this product in vehicles with positive ground and/or voltages other than 12V may result in damage to the product and/or vehicle and will void the warranty.



**PLEASE MAKE SURE TO CAREFULLY READ AND UNDERSTAND ALL INSTRUCTIONS PRIOR TO INSTALLATION**



## MOUNTING THE AMPLIFIER

Choose a location for the amplifier with ample ventilation for optimum cooling performance. Be sure the amplifier is mounted with at least 2-inches (50mm) of clearance around the chassis, and never fully enclosure the amplifier in a confined space without active ventilation. It is strongly discouraged to mount the amplifier upside down as this will limit the heatsink's ability to remove heat from the circuitry. Also avoid mounting in areas of direct sunlight and in areas of high vibration, such as a subwoofer enclosure.

Proper mounting consists of the chassis being mounted with the base of the amplifier parallel with the floor or perpendicular to the floor with the fins of the heatsink facing upward for effective cooling.

Your amplifier should always be installed in a location that will remain free of moisture and dirt, and in a manner that does not interfere with any of the electronics or safety gear of the vehicle.

For safety purposes, be sure to take the time to properly mount the amplifier using suitable mounting hardware so the amplifier does not come loose in the event of a collision or unforeseen circumstance.

## PROTECTION

Please note that there are no chassis mounted fuses on the MPS amplifiers. Instead our design uses a microprocessor controlled protection circuit which enables the amplifier to optimize the current flow coming into the power supply. This design lowers loss within the circuitry, increase the power output and improves the sound dynamics of the amplifier for the best listening experience. However, for the safety of you and your vehicle, please follow instructions for installing an inline fuse with your amplifier.

## PLANNING AND INSTALLATION

For best results, determine the best configuration of your new amplifier and plan the wiring routes to ease installation and optimize performance.

- **IMPORTANT!** Disconnect the vehicle's primary ground terminal from the battery post prior to commencing the installation.



- Make sure the mounting location you chose for the amplifier does not interfere with any functions of the vehicle mechanics and/or electronic devices. Also, be aware of the locations of the gas tank, wiring harnesses, fuel and brake lines, and other vital components of the vehicle prior to drilling any holes in the vehicle's chassis.
- Select high quality signal cables and proper wire. It is highly recommended to use 100% OFC (oxygen free copper) power and speaker wire of proper size for best performance and longevity of the product.
- Do not run power or audio cables on the exterior of the vehicle, including underneath, as this can result in severe damage to the vehicle and person.
- Avoid running power and audio cables next to sensitive electronics within the vehicle, and be sure to route the signal cables away from the power cables.
- Always use rubber grommets when running wire through metal walls or barriers, and use loom to protect the cable from sharp edges or areas of high heat.
- Power amplifiers place an increased load on the electrical charging system. Generally, factory charge systems in good condition should be able to withstand the extra load of an MPS amplifier without a problem. However, multiple amplifier systems can draw excess current and create a serious strain on the electrical system. It is best to consult your audio specialist for advise on whether or not it is necessary to upgrade your electrical system to meet the demands of the audio system.
- Place an insulated in-line fuse holder of the appropriate current capacity within 16 inches (40cm) of the battery positive (+) terminal. Connect to this to the power cable connecting the positive terminal of the amplifier. This fuse is designed to protect the vehicle in the event of a short. Only install the fuse once the power cable has been secured to the amplifier.
- Locate a solid metal area as close to the amplifier as possible to connect the ground wire terminal. Use the same gauge wire for ground as for the power wire. The length of the ground wire should not exceed 36 inches (90cm) from the amplifier. To ensure a solid connection, remove surface paint at the ground point prior to securing the connector in place.

# MPS 4.400 / Features

## 1. Power Status Indicator

LED illuminates blue when amplifier is properly powered on

## 2. Protection Status Indicator

LED will illuminate red when the amplifier is in faults into protect mode related to over current, short circuit, thermal protection or internal error within the amplifier. If the fault is caused by thermal protection, the amplifier will reset automatically once the heatsink has cooled to about 70°C (160°F). If the protection LED stays illuminated, turn the amplifier off and check the speakers and wiring.

## 3. Negative Chassis Ground Connector

Connect to a matching 8 gauge or larger OFC (oxygen-free copper) wire for ground as used the power wire. The length of the ground wire should not exceed 36 inches (90cm) from the amplifier. To ensure a solid connection, remove surface paint at the ground point prior to securing the connector in place.

## 4. Remote Turn-On Connector

Connect to wire lead from a switched +12V source. This could be from a head unit or switched ignition lead. If neither of these sources is available, switch Turn On Mode to signal sensing or DC offset.

## 5. +12VDC Power Connection

For safety and optimum performance, connect an 8 gauge or larger OFC (oxygen-free copper) wire to the +12V terminal. Connect directly to the positive terminal (+12V) of the car's battery via a 50A inline fuse. The fuse must be located within 16 inches (40cm) of the battery.

## 6-7. Left & Right Speaker Outputs

Connect speaker wire up to 10 gauge. Group A and Group B connections can be configured in stereo using the + and - of both L & R outputs, or in a mono configuration using the L+ and R- within Group A or Group B (DO NOT cross-wire between Group A and B). 3-Channel can also be configured using a stereo in Group A and mono in Group B.

## 8-9. RCA Inputs

Accepts both low-level and high-level signal via RCA style connectors. Use Input Voltage Selector to choose appropriate voltage level, and 2/4 channel input selector for number of inputs used. High-level inputs require the MPS-HL line level adaptor (sold separately) to convert amplified speaker outputs from factory audio systems to RCA style connections.

## 10. High/Low Level Input Voltage Selector

Select signal input voltage based on the type of input used. When using an aftermarket radio, DSP or line level convertor, select Low for levels up to 5V. When using high-level input from an amplified factory audio system, select High for levels up to 10V.

## 11. 2/4 Channel Input Mode Selector

Selector allows amplifier to accept signal from 2 or 4 channels of input.

Selecting 2CH will take signal from Group A L and R input only and send signal to Group B L and R channels.

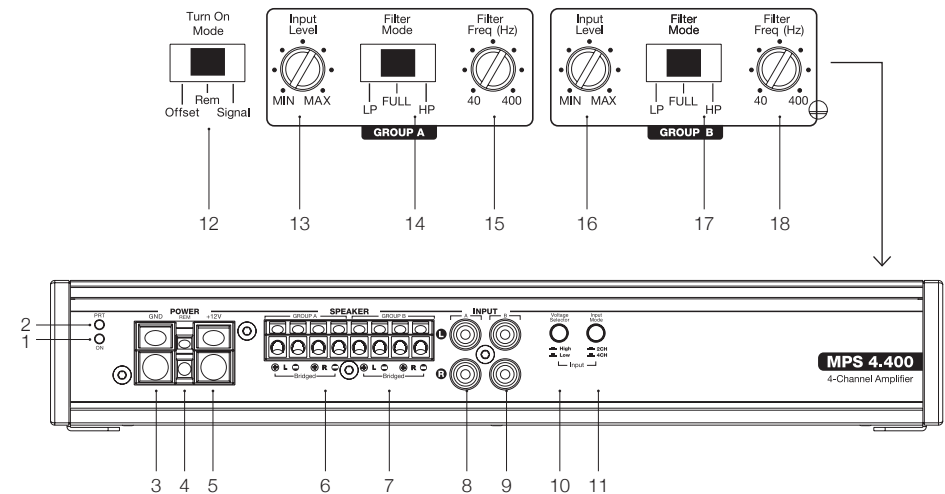

## 12. Turn On Mode Selector

Select between 3 modes to turn on the amplifier. When using a switched lead such as the remove output of a radio, select the default position REM. When connecting to a factory audio system or alternative source, select Signal and the amplifier will turn on when it senses voltage through the inputs. DC (DC offset) may be used in some vehicles where signal sensing does not reliably turn the amplifier on.

**13 & 16. Input Sensitivity Controller**

The input sensitivity controller (gain) is used to properly match input signal levels from the signal source to optimize the amplifier outputs. THIS IS NOT A VOLUME CONTROL! To properly set, the maximum unclipped output from the radio or source must be known using either an oscilloscope or, at minimum, a multi-meter and test program. The amplifier can then be properly set to maximize output. If the gain is not set properly the amplifier may clip early and damage your speakers and the amplifier itself. It is highly recommended to use an audio specialist to properly adjust. Independent gain controls are available for Group A and Group B channels.

**14 & 17. Crossover Filter Selector**

Select between Full (full range), LP (lowpass) and HP (highpass) depending on the requirements of the speakers in your system. Selecting LP or HP turns on a 12dB filter that can be adjusted using the Filter Frequency. This is selected independently for Group A and Group B channels.

**15 & 18. Crossover Frequency Controller**

Use this feature to adjust the frequency of the crossover filter between 40 and 400Hz. This is controlled independently for Group A and Group B channels.

**MPS 4.400 / Power And Signal Connections**

**4-CHANNEL LOW LEVEL - RCA INPUTS**

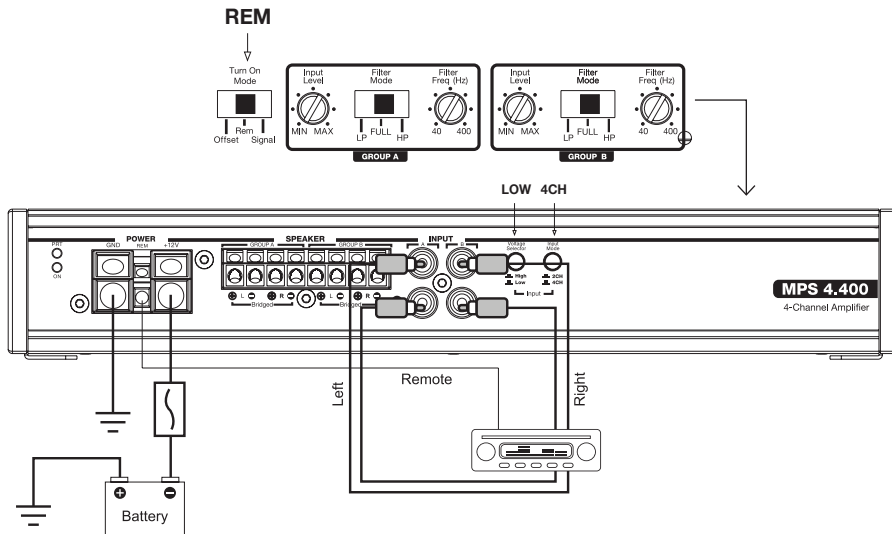

**4-CHANNEL HIGH LEVEL - SPEAKER TO RCA INPUTS**

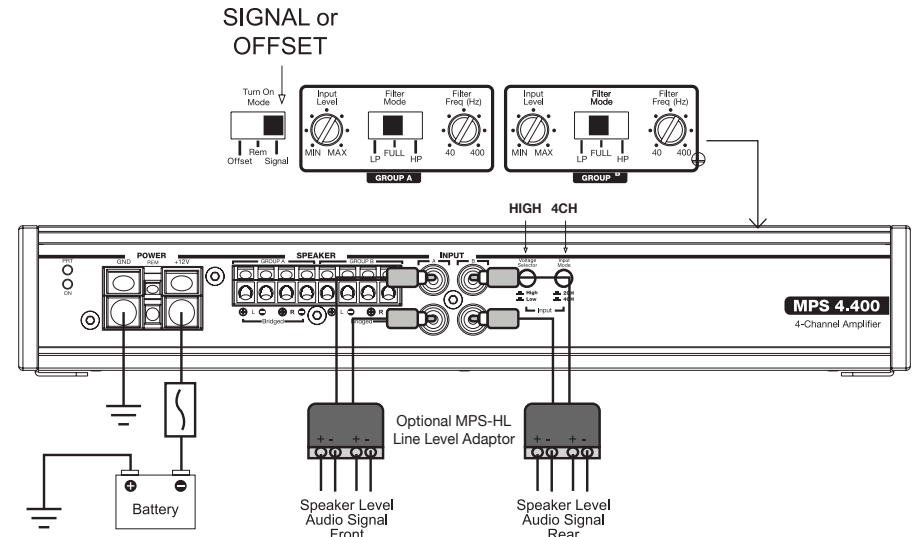

**2-CHANNEL LOW LEVEL - RCA INPUTS**

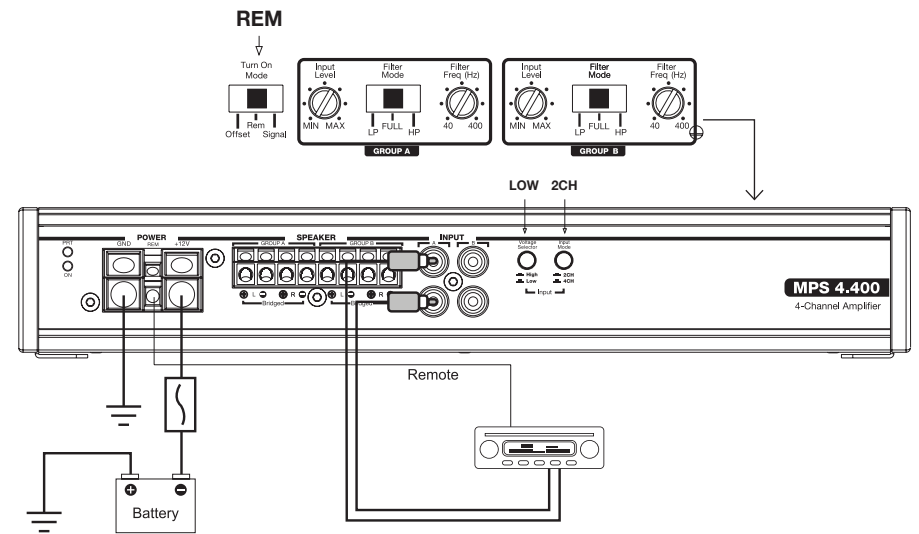

### 2-CHANNEL HIGH LEVEL - SPEAKER TO RCA INPUTS

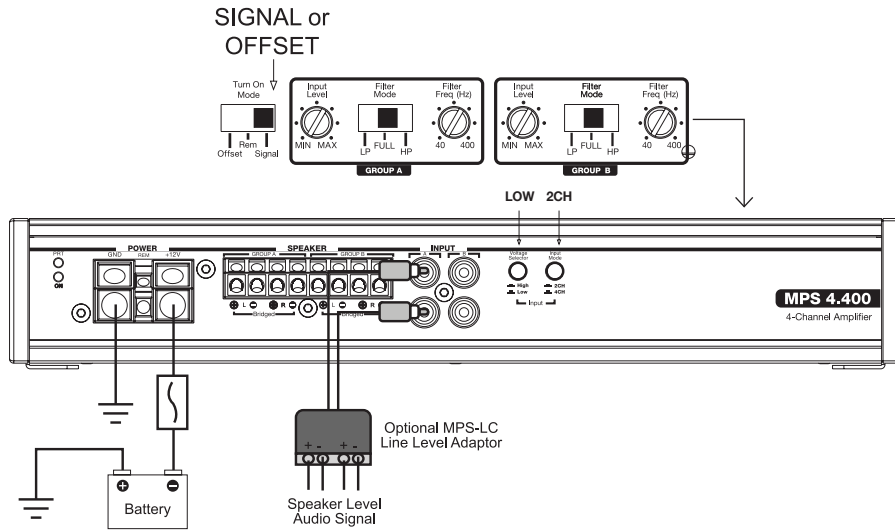

### 2-CHANNEL BRIDGED OUTPUTS - LOW LEVEL RCA INPUTS

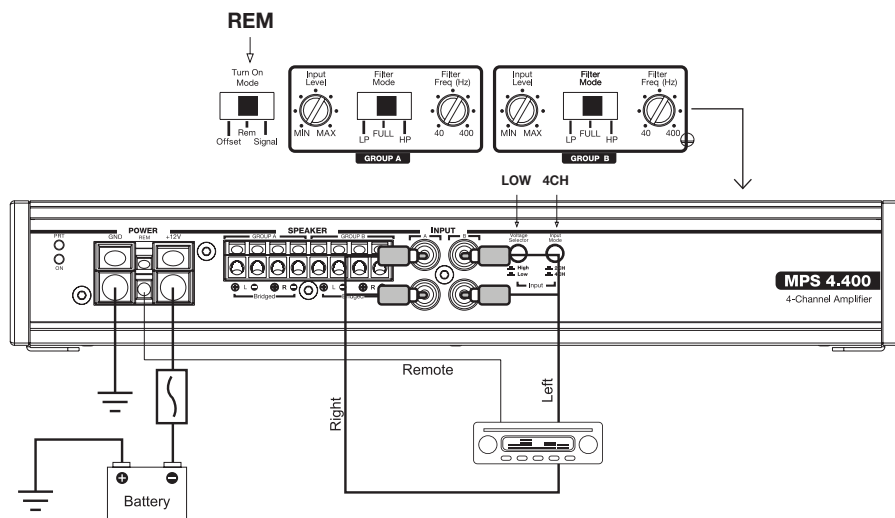

## MPS 4.400 / Speaker Connections

### 4-CHANNEL STEREO MODE - HIGHPASS

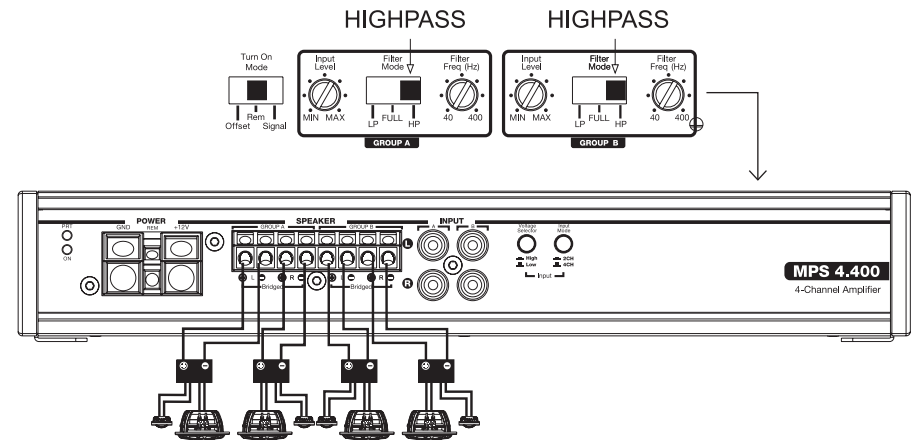

### 3-CHANNEL STEREO + MONO MODE - HIGHPASS + LOWPASS

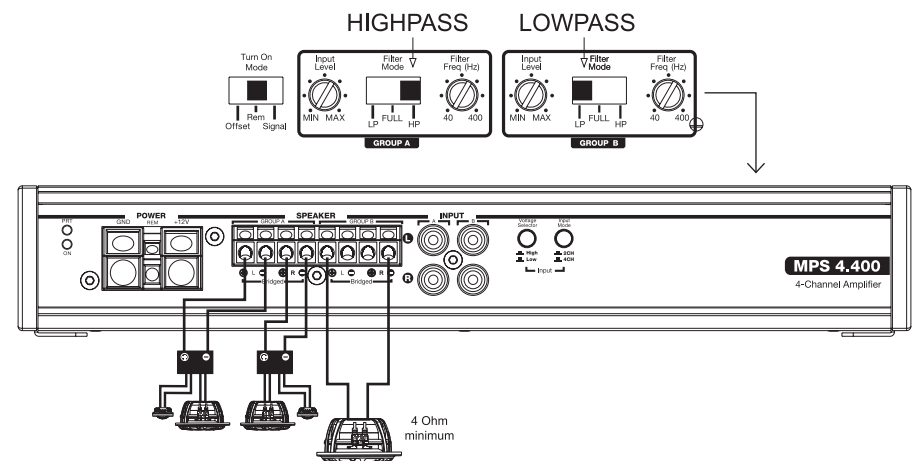

## 2-CHANNEL BRIDGED MODE - STEREO HIGHPASS

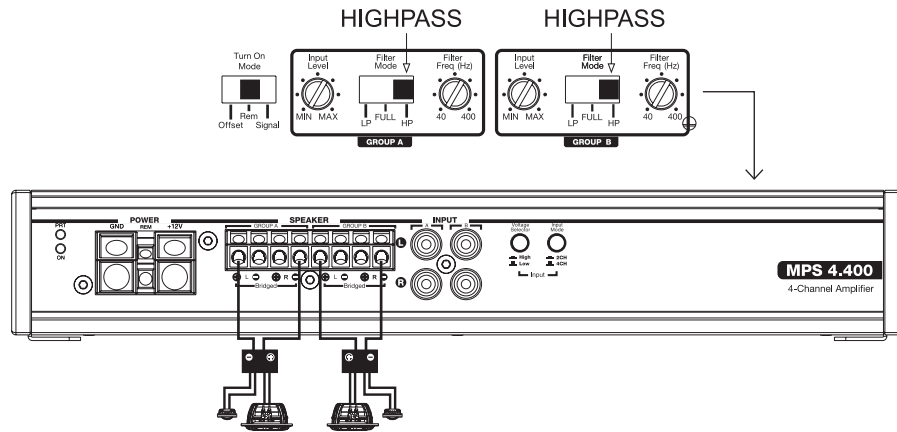

## 2-CHANNEL BRIDGED MODE - LOWPASS SUBWOOFER

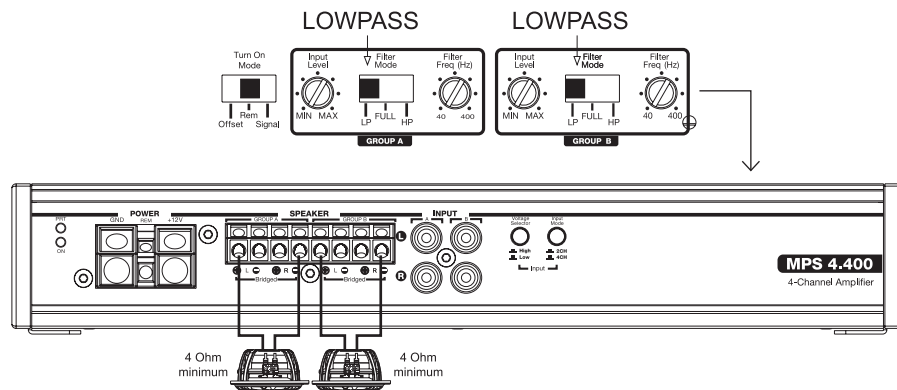

# MPS 1.550 / Features

### 1. Power Status Indicator

LED illuminates blue when amplifier is properly powered on

### 2. Protection Status Indicator

LED will illuminate red when the amplifier is in faults into protect mode related to over current, short circuit, thermal protection or internal error within the amplifier. If the fault is caused by thermal protection, the amplifier will reset automatically once the heatsink has cooled to about 70°C (160°F). If the protection LED stays illuminated, turn the amplifier off and check the speakers and wiring.

### 3. Negative Chassis Ground Connector

Connect to a matching 8 gauge or larger OFC (oxygen-free copper) wire for ground as used the power wire. The length of the ground wire should not exceed 36 inches (90cm) from the amplifier. To ensure a solid connection, remove surface paint at the ground point prior to securing the connector in place.

### 4. Remote Turn-On Connector

Connect to wire lead from a switched +12V source. This could be from a head unit or switched ignition lead. If neither of these sources is available, switch Turn On Mode to signal sensing or DC offset.

### 5. +12VDC Power Connection

For safety and optimum performance, connect an 8 gauge or larger OFC (oxygen-free copper) wire to the +12V terminal. Connect directly to the positive terminal (+12V) of the car's battery via a 50A inline fuse. The fuse must be located within 16 inches (40cm) of the battery.

### 6. Subwoofer Outputs

There are two speaker connections are labeled + and -. The two output connections are internally parallel as this is a single channel amplifier. When using both sets of + and -, you will need to use Ohm's law to calculate the impedance in a parallel configuration. Connect speaker wire up to 10 gauge.

### 7. Remote Level Control

Connector for optional MPS-R1 remote subwoofer level control. This allows the user to adjust the output level of the amplifier on the fly from a remote location within the vehicle.

### 8. High/Low Level Input Voltage Selector

Select signal input voltage based on the type of input used. When using an aftermarket radio, DSP or line level convertor, select Low for levels up to 5V. When using high-level input from an amplified factory audio system, select High for levels up to 20V.

### 9. RCA Inputs

Accepts both low-level and high-level signal via RCA style connectors. Use Input Voltage Selector to choose appropriate voltage level. High-level inputs require the MPS-HL line level adaptor (sold separately) to convert amplified speaker outputs from factory audio systems to RCA style connections.

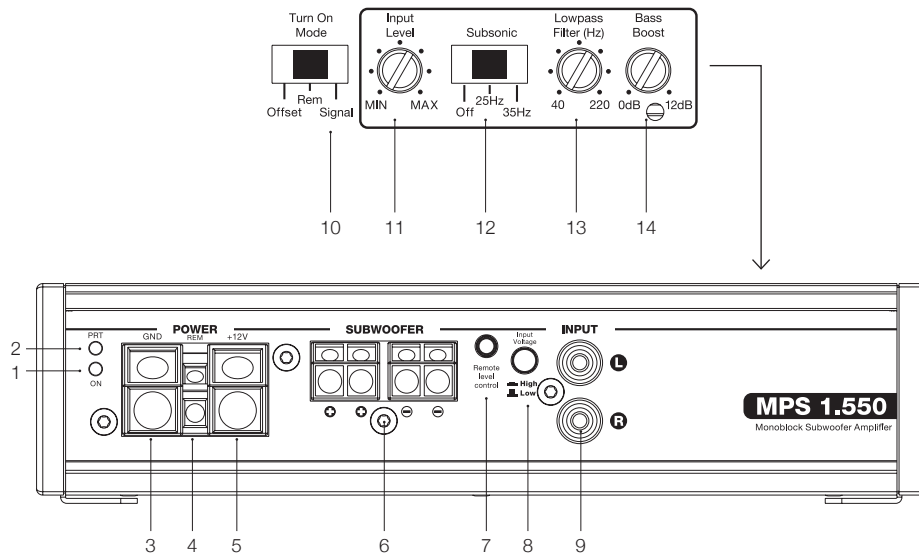

### 10. Turn On Mode Selector

Select between 3 modes to turn on the amplifier. When using a switched lead such as the remove output of a radio, select the default position REM. When connecting to a factory audio system or alternative source, select Signal and the amplifier will turn on when it senses voltage through the inputs. DC (DC offset) may be used in some vehicles where signal sensing does not reliably turn the amplifier on.

### 11. Input Sensitivity Controller

The input sensitivity controller (gain) is used to properly match input signal levels from the signal source to optimize the amplifier outputs. THIS IS NOT A VOLUME CONTROL! To properly set, the maximum unclipped output from the radio or source must be known using either an oscilloscope or, at minimum, a multi-meter and test program. The amplifier can then be properly set to maximize output. If the gain is not set properly the amplifier may clip early and damage your speakers and the amplifier itself. It is highly recommended to use an audio specialist to properly adjust.

### 12. Subsonic Filter Selector

Designed to be used with small subwoofers or vented enclosures with a high tuning frequency, users can opt to select a 12dB subsonic filter (highpass crossover) centered at either 25Hz or 35Hz.

### 13. Lowpass Frequency Controller

This amplifier is designed as strictly a subwoofer amplifier and therefore the crossover cannot be defeated. The crossover frequency controller allows the user to adjust the frequency of the Lowpass crossover filter between 40 and 220Hz.

### 14. Bass Boost Controller

This allows the user to boost the output of the amplifier centered around 45Hz with a range of 0 to +12dB.



### LOW LEVEL RCA INPUTS

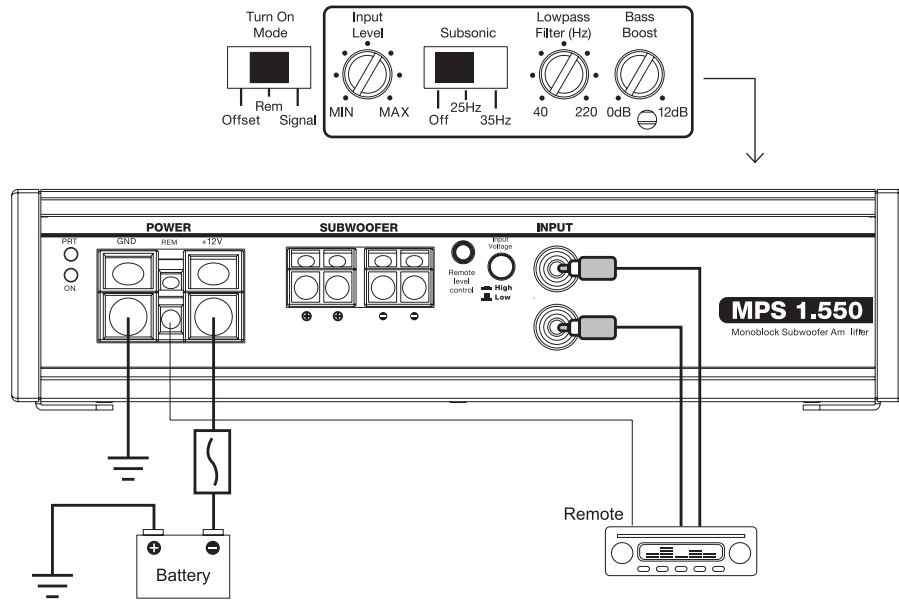

### HIGH LEVEL SPEAKER TO RCA INPUTS

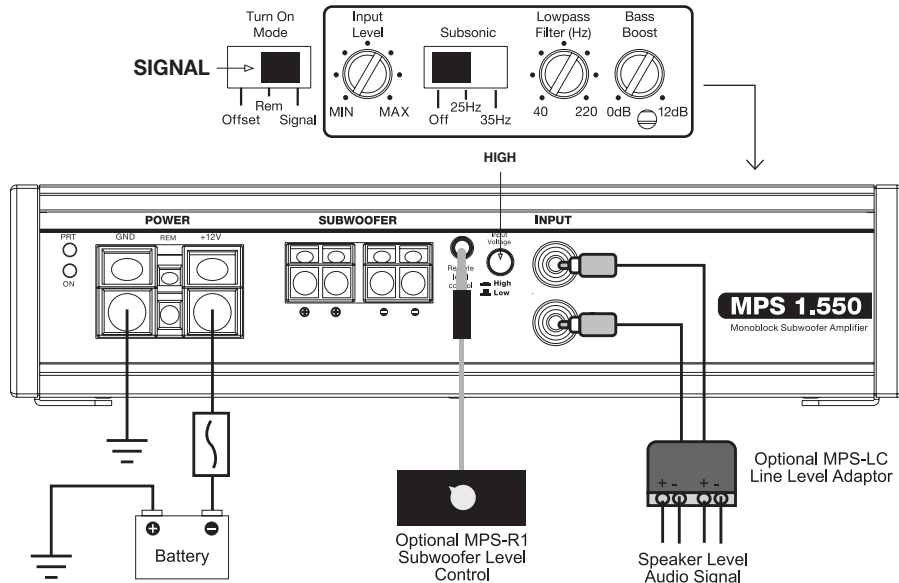

## MPS 1.550 / Speaker Connections

### SINGLE SUBWOOFER CONNECTION

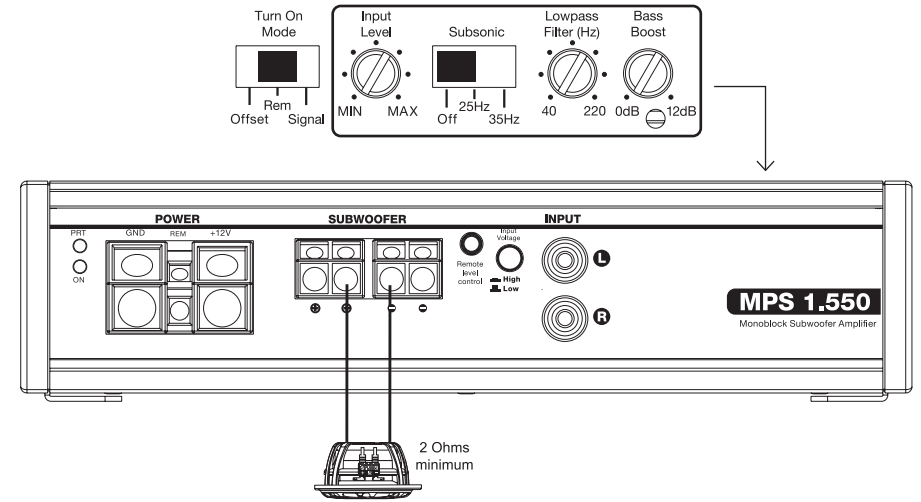

### DUAL SUBWOOFER CONNECTION

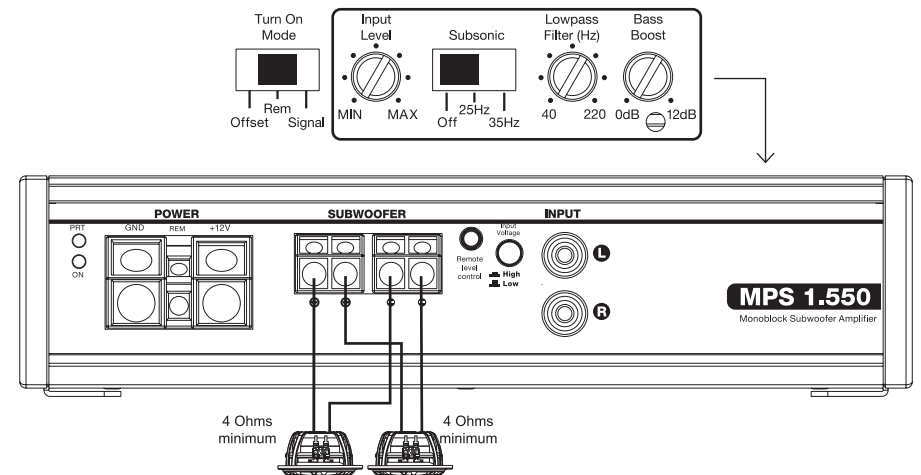



## MPS 5.950 / Features

### 1. Power Status Indicator

LED illuminates blue when amplifier is properly powered on

### 2. Protection Status Indicator

LED will illuminate red when the amplifier is in faults into protect mode related to over current, short circuit, thermal protection or internal error within the amplifier. If the fault is caused by thermal protection, the amplifier will reset automatically once the heatsink has cooled to about 70°C (160°F). If the protection LED stays illuminated, turn the amplifier off and check the speakers and wiring.

### 3. Negative Chassis Ground Connector

Connect to a matching 4 gauge OFC or larger OFC (oxygen-free copper) wire for ground as used the power wire. The length of the ground wire should not exceed 36 inches (90cm) from the amplifier. To ensure a solid connection, remove surface paint at the ground point prior to securing the connector in place.

### 4. Remote Turn-On Connector

Connect to wire lead from a switched +12V source. This could be from a head unit or switched ignition lead. If neither of these sources is available, switch Turn On Mode to signal sensing or DC offset.

### 5. +12VDC Power Connection

For safety and optimum performance, connect an 4 gauge OFC or larger OFC (oxygen-free copper) wire to the +12V terminal. Connect directly to the positive terminal (+12V) of the car's battery via a 50A inline fuse. The fuse must be located within 16 inches (40cm) of the battery.

### 6-8. RCA Inputs

Accepts both low-level and high-level signal via RCA style connectors. Separate inputs can be used for Group A, Group B and Subwoofer channels. Use Input Voltage Selector to choose appropriate voltage level, and 2/4 channel and subwoofer mode input selector for number of inputs used. High-level inputs require the MPS-HL line level adaptor (sold separately) to convert amplified speaker outputs from factory audio systems to RCA style connections.



### 9. High/Low Level Input Voltage Selector

Select signal input voltage based on the type of input used. When using an aftermarket radio, DSP or line level convertor, select Low for levels up to 5V. When using high-level input from an amplified factory audio system, select High for levels up to 10V on Group A & B inputs, and up to 20V on subwoofer inputs.

### 10. 2/4 Channel Input Mode Selector

Selector allows amplifier to accept signal from 2 or 4 channels of input.

Selecting 2CH will take signal from Group A L and R input only and send signal to Group B L and R channels.

### 11. Subwoofer Input Mode Selector

Selector allows amplifier to accept signal from Subwoofer inputs or Group A & B channels of input. Selecting 4CH will take signal from Group A and B only and send signal to Subwoofer channel.

### 12. Subwoofer Outputs

There are two speaker connections are labeled + and -. The two output connections are internally parallel as this is a single channel amplifier. When using both sets of + and -, you will need to use Ohm's law to calculate the impedance in a parallel configuration. Connect speaker wire up to 10 gauge. Group A Left & Right Speaker Outputs

### 13-14. Left & Right Speaker Outputs

Connect speaker wire up to 10 gauge. Group A and Group B connections can be configured in stereo using the + and - of both L & R outputs, or in a mono configuration using the L+ and R- within Group A or Group B (DO NOT cross-wire between Group A and B).

### 15. Input Sensitivity Controller

The input sensitivity controller (gain) is used to properly match input signal levels from the signal source to optimize the amplifier outputs. THIS IS NOT A VOLUME CONTROL! To properly set, the maximum unclipped output from the radio or source must be known using either an oscilloscope or, at minimum, a multi-meter and test program. The amplifier can then be properly set to maximize output. If the gain is not set properly the amplifier may clip early and damage your speakers and the amplifier itself. It is highly recommended to use an audio specialist to properly adjust.

### 16. Subsonic Filter Selector

Designed to be used with small subwoofers or vented enclosures with a high tuning frequency, users can opt to select a 12dB subsonic filter (highpass crossover) centered at either 25Hz or 35Hz.

**17. Lowpass Frequency Controller**

This amplifier is designed as strictly a subwoofer amplifier and therefore the crossover cannot be defeated. The crossover frequency controller allows the user to adjust the frequency of the Lowpass crossover filter between 40 and 220Hz.

**18. Bass Boost Controller**

This allows the user to boost the output of the amplifier centered around 45Hz with a range of 0 to +12dB

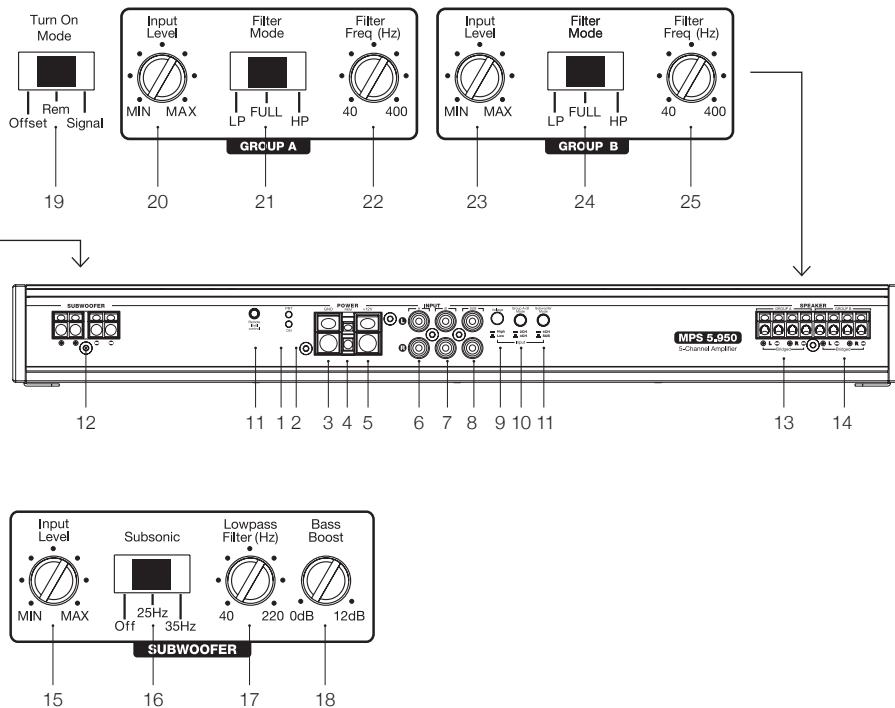

**19. Turn On Mode Selector**

Select between 3 modes to turn on the amplifier. When using a switched lead such as the remove output of a radio, select the default position REM. When connecting to a factory audio system or alternative source, select Signal and the amplifier will turn on when it senses voltage through the inputs. DC (DC offset) may be used in some vehicles where signal sensing does not reliably turn the amplifier on. Group A Input Sensitivity Controller

**20 & 23. Input Sensitivity Controller**

The input sensitivity controller (gain) is used to properly match input signal levels from the signal source to optimize the amplifier outputs. THIS IS NOT A VOLUME CONTROL! To properly set, the maximum unclipped output from the radio or source must be known using either an oscilloscope or, at minimum, a multi-meter and test program. The amplifier can then be properly set to maximize output. If the gain is not set properly the amplifier may clip early and damage your speakers and the amplifier itself. It is highly recommended to use an audio specialist to properly adjust. Independent gain controls are available for Group A and Group B channels.

**21 & 24. Crossover Filter Selector**

Select between Full (full range), LP (lowpass) and HP (highpass) depending on the requirements of the speakers in your system. Selecting LP or HP turns on a 12dB filter that can be adjusted using the Filter Frequency. This is selected independently for Group A and Group B channels.

**22 & 25. Crossover Frequency Controller**

Use this feature to adjust the frequency of the crossover filter between 40 and 400Hz. This is controlled independently for Group A and Group B channels.

**MPS 5.950 / Power And Signal Connections**

**6-CHANNEL LOW LEVEL RCA INPUT ( FRONT + REAR + SUB )**

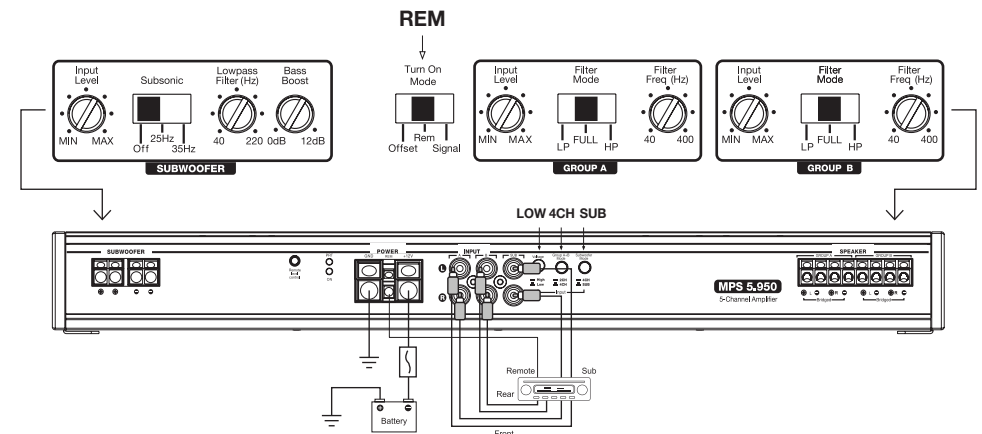

4-CHANNEL LOW LEVEL RCA INPUT ( FRONT + SUB )

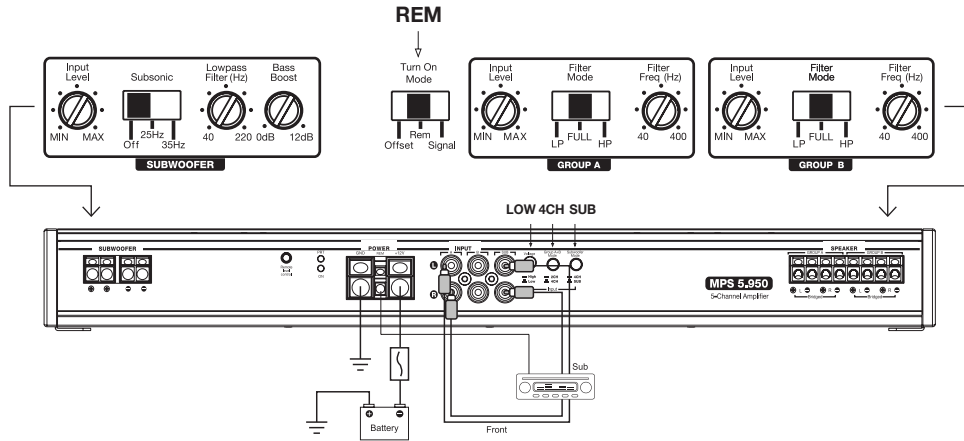

2-CHANNEL LOW LEVEL RCA INPUT - FRONT ONLY

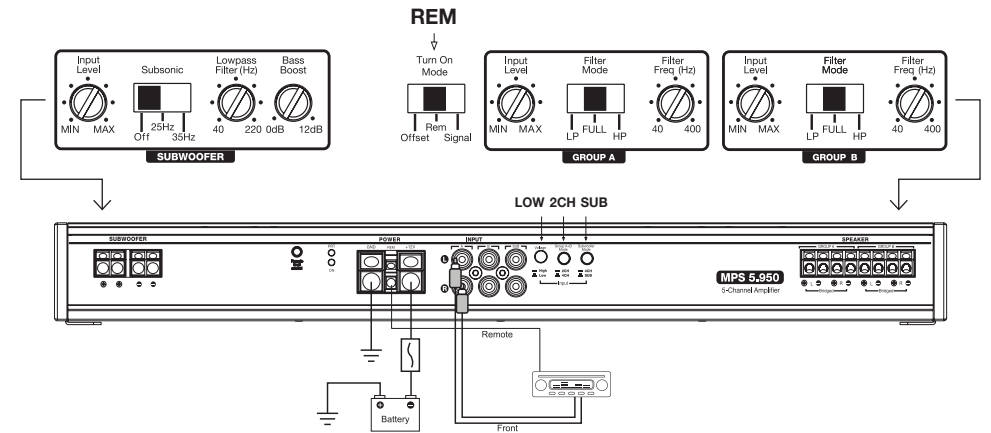

4-CHANNEL LOW LEVEL RCA INPUT ( FRONT + REAR )

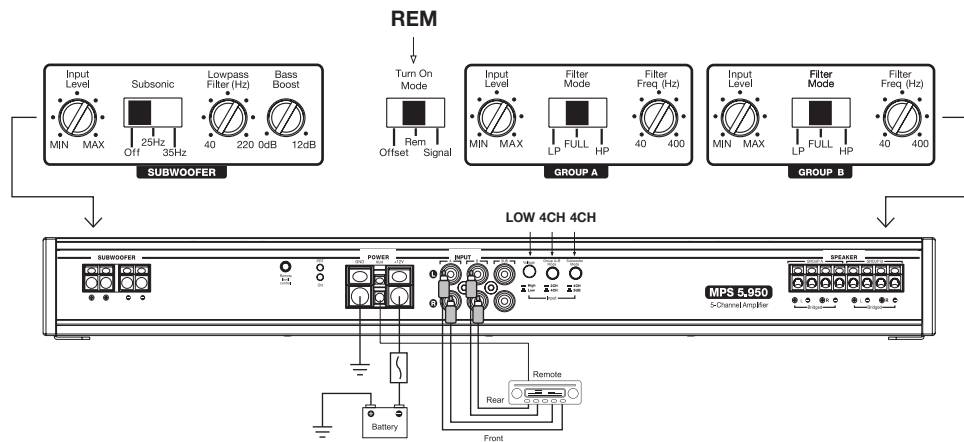

2-CHANNEL HIGH LEVEL RCA INPUT - FRONT ONLY

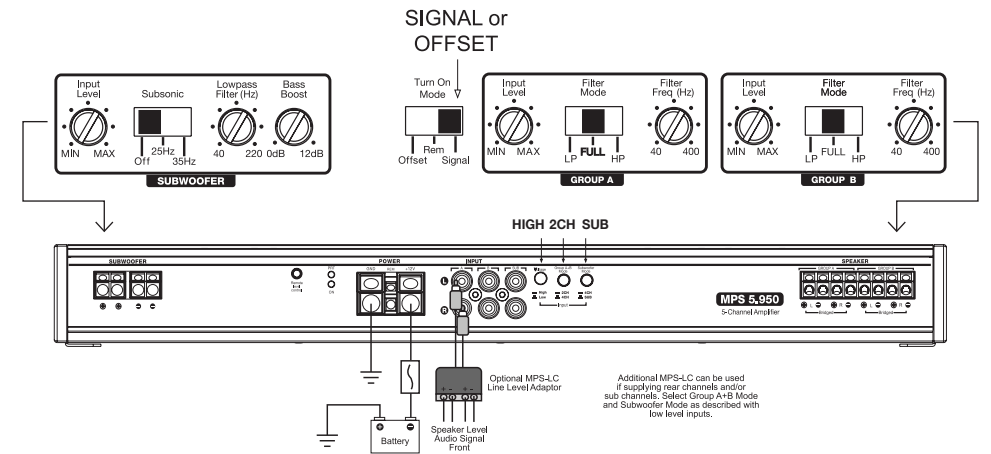

# MPS 5.950 / Speaker Connections

## 5-CHANNEL STEREO/MONO - MODE

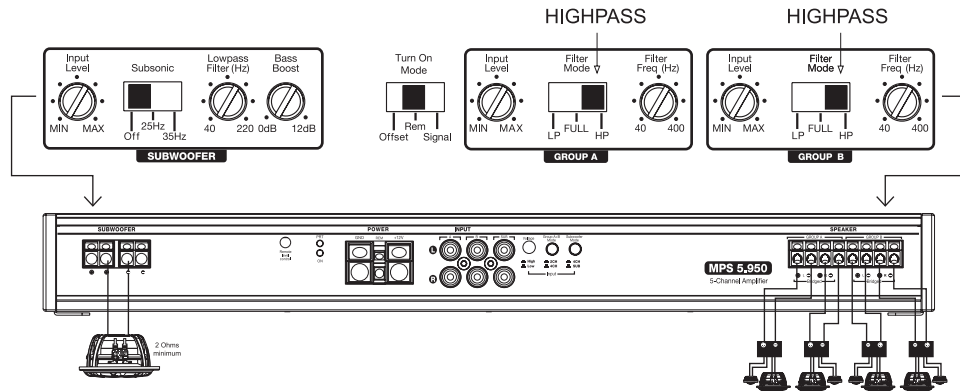

## 3-CHANNEL BRIDGED - STEREO/MONO MODE

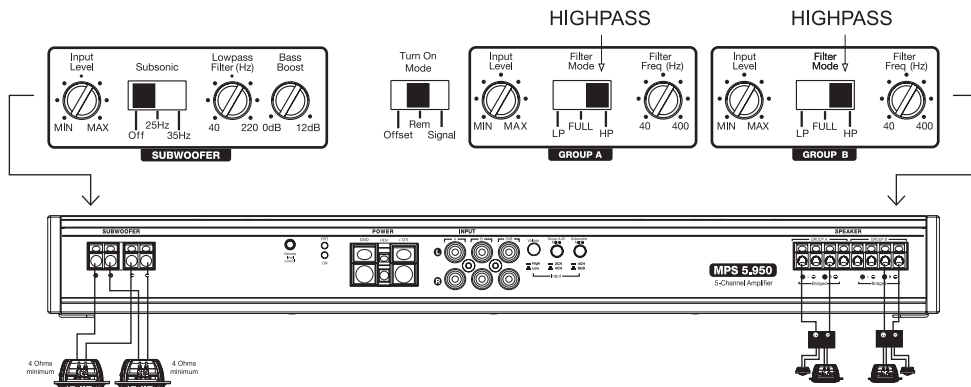

## WARRANTY

Morel warrants this product to be free of defects in materials and workmanship for a period of two (2) years from the original date of purchase if installed by an authorized installer and one (1) year if sold over the counter or online. This warranty is not transferable and applies only to the original purchaser from an authorized Morel dealer in the USA only. Should service be necessary under this warranty for any reason due to manufacturing defect or malfunction, Morel will (at its discretion) repair or replace the defective product with new or remanufactured product at no charge. Damage caused by the following is not covered under warranty: accident, misuse, abuse, product modification or neglect, failure to follow installation instructions, unauthorized repair attempts, misrepresentations by the seller. This warranty does not cover incidental or consequential damages and does not cover the cost of removing or reinstalling the unit(s). Cosmetic damage due to accident or normal wear and tear is not covered under warranty.

## INTERNATIONAL WARRANTIES:

Products purchased outside the USA are covered only by that country's Authorized Morel reseller and not by Morel. Consumers needing service or warranty information for these products must contact that country's reseller for information.



MODEL	MPS 4.400	MPS 1.550	MPS 5.950
<b>RMS POWER @ 14V</b>			
4 Ohm	4 x 70w	1 x 350w	4 x 70w + 1 x 350w
2 Ohm	4 x 100w	1 x 550	4 x 100w + 1 x 550w
Main Channels Bridged, 4 ohm	2 x 200w	N/A	2 x 200w (Sub N/A)
Minimum Impedance	2 Ohms	2 Ohms	2 Ohms
<b>SPECIFICATIONS</b>			
THD+N	0.05%	0.15%	0.05% (main), 0.15% (sub)
Frequency Response (main)	10Hz-30kHz	N/A	10Hz-30kHz
Frequency Response (sub)	N/A	10-220Hz	10-220Hz
S/N Ratio (Rated Power, A-weighted)	100dB	100dB	100dB
Channel separation	64dB	N/A	64dB
Damping Factor	>100	>150	>100 (main), >150 (sub)
Selectable Input Range	Yes (x1/x2)	Yes (x1/x4)	Yes (x1/x2/x4)
Input Voltage Range (main, x1)	200mV-5V	N/A	200mV-5V
Input Voltage Range (main, x2)	400mV-10V	N/A	400mV-10V
Input Voltage Range (sub, x1)	N/A	200mV-5V	200mV-5V
Input Voltage Range (sub, x4)	N/A	800mV-20V	800mV-20V
<b>PREAMP</b>			
Filters (main)	HP/LP, 40Hz-400Hz	N/A	HP/LP, 40Hz-400Hz
Filters (sub)	N/A	LP, 40-220Hz	LP, 40-220Hz
Crossover slope	12dB/Octave	12dB/Octave	12dB/Octave
Subwoofer Level Control	No	YES, 0-20dB	YES, 0-20dB
Channel Input Mode	Yes (2/4 channel)	No	Yes (2/4/6 channel)
Subsonic Filter	No	Selectable Off/25Hz/35Hz	Selectable Off/25Hz/35Hz
Remote Level Control (sub)	N/A	Optional MPS-R1	Optional MPS-R1
<b>TURN ON</b>			
DC Offset	Yes	Yes	Yes
Signal Sensing	Yes	Yes	Yes
Remote	Yes	Yes	Yes
<b>PHYSICAL SPECIFICATIONS</b>			
Height (H)	2" (51mm)	2" (51mm)	2" (51mm)
Width (W)	6.7" (170mm)	6.7" (170mm)	6.7" (170mm)
Length (L)	12.39" (314.5mm)	8.44" (214.5mm)	18.29" (464.5mm)
<b>FUSE RECOMMENDATION</b>	<b>*INLINE FUSE MUST BE USED WITHIN 16" (40cm) OF BATTERY</b>		
	40 Amp	50 Amp	80 Amp



Morel constantly developing new technology and process to improve its products Morel reserves its right to modify specifications without notice. Images may not conform to specific product listed in this manual.



[WWW.MORELHIFI.COM](http://WWW.MORELHIFI.COM)